

## Chalcopyrite leaching by amino acid solutions in the presence of hydrogen peroxide

Nargiza Nurtazina <sup>1</sup>, Nikolai Uvarov <sup>2</sup>, Ryskul Azhigulova <sup>1</sup>, Pavel Tyapkin <sup>2</sup>

<sup>1</sup> Al-Farabi Kazakh National University, Almaty 050040, Kazakhstan

<sup>2</sup> Institute of Solid State Chemistry and Mechanochemistry of SB RAS, Novosibirsk 630128, Russia

Corresponding author: [nurtazina.nn@gmail.com](mailto:nurtazina.nn@gmail.com) (Nargiza Nurtazina)

**Abstract:** It is demonstrated that amino acids such as glycine, betaine, and lysine may be applied as selective copper leaching agents in the process of hydrochemical oxidation of chalcopyrite at atmospheric pressure and in the temperature range 25–65 °C. The advantage of the proposed method is its relative environmental friendliness. Solid samples of the initial mineral and leached chalcopyrite residues were analyzed by X-ray diffraction analysis, and Mössbauer and Raman spectroscopy. The results of the atomic absorption analysis showed that copper's extraction efficiency increased when the experiment's duration was raised and when the process temperature was higher. The leaching ability of amino acids was evaluated by the specific leaching rate of chalcopyrite in these reagents. Amino acid leaching was thought to be mainly due to the complexation of copper (II) glycinate, copper (II) betainate and copper (II) lysinate. This reaction can be enhanced by adding hydrogen peroxide to the system as an oxidant. It was determined that glycine was more effective as a leaching agent than betaine and lysine. Based on experimental data, it was assumed that the most possible mechanism is selective copper leaching due to the formation of chalcopyrite-based solid solution  $\text{Cu}_{1-x}\text{FeS}_2$ .

**Keywords:** chalcopyrite, amino acid leaching, glycine, betaine, lysine

### 1. Introduction

A major task of modern metallurgy is to upgrade existing and develop new methods of extracting metals and other valuable components from ores, concentrates, minerals and tailings. Recently, considerable attention has been paid to the hydrometallurgical process, in which the most important stage is leaching, where ores, concentrates, semi-products and production wastes are treated with aqueous solutions of chemical reagents (Yoo et al., 2010; Safarzadeh et al., 2012; Choubey et al., 2018; Martínez-Gómez et al., 2018; Moyo et al., 2018; Beiza et al., 2019; Moyo et al., 2019; Tiburcio-Munive et al., 2020). Hydrometallurgical methods have the following advantages (Bhargava et al., 2016): provide efficient processing of low-grade ores and extraction of more valuable components through complex processing of raw materials; involve selective chemical reactions and low operating temperatures; require lower energy and economic costs; include safer working conditions (no dust and toxic gases), and reduce environmental pollution by hazardous substances. Hydrometallurgical metal extraction, where leaching, separation, concentration and reduction to metal are carried out at close to ambient temperature, is becoming increasingly competitive compared to conventional high-temperature processes.

Chalcopyrite is the most widespread primary copper sulfide mineral, as it accounts for over 70 % of the world's copper resources. However, chalcopyrite is a very refractory copper raw material, so its hydrochemical processing is difficult compared to secondary sulfides (chalcocite, bornite) and oxides (azurite, malachite) (Zhao et al., 2019). Therefore, the development of methods for copper extraction from chalcopyrite is a relevant task in modern hydrometallurgy.

The traditional method of copper extraction from chalcopyrite is mineral leaching with inorganic acid solutions such as hydrochloric acid, sulfuric acid and nitric acid. However, these acids can cause environmental problems and have a strong corrosive effect on the used equipment. In addition, acid

consumption increases substantially when treating raw materials containing acid-adsorbing rocks. Acid leaching also dissolves impurities (Fe etc.), the presence of which creates complications for the subsequent processing stages. Papers (Liang et al., 2013; Zhao et al., 2015) discuss bacterial leaching methods for sulfide ores. Bioleaching is an environmentally friendly, low-energy process that does not release harmful gases into the environment. Nevertheless, this process has certain limitations. For example, copper extraction using heap leaching technology requires a longer reaction time (up to several months) than conventional leaching. The reaction of the microorganisms to weather conditions must also be closely monitored, as their vital functions depend on temperature (Panda et al., 2012).

Recently there has been growing interest in the use of complexing organic compounds as well as mixtures of inorganic and organic substances as agents for copper sulfide mineral leaching (Ruiz-Sánchez and Lapidus, 2017; Olvera et al., 2018; Ghomi et al., 2019; Solís Marcial et al., 2019; Kartal et al., 2020; Carlesi et al., 2022). The effectiveness of organic reagents is due to their relatively low corrosivity, their increased selectivity through their ability to form complex compounds with the extracted metals and their ability to prevent the formation of a passive layer (Solís-Marcial and Lapidus, 2013). Amino acids are considered promising and alternative organic complexing leaching agents in the hydrometallurgy field (Eksteen et al., 2017; Olvera et al., 2017; Oraby et al., 2017; Azadi et al., 2019). The authors (Shin et al., 2019) first used an alkaline glycine-peroxide system to leach copper from chalcopyrite concentrate. It is known that, depending on the pH of the medium, amino acids can be in the form of a cation in an acidic medium and as an anion in an alkaline medium (Sheikhian et al., 2020). At high pH values, positive copper ions interact with negative amino acid ions to form stable chelate complexes.

Despite the promising use of organic compounds, in particular  $\alpha$ -amino acids, as leaching reagents for the transfer of non-ferrous metals from the mineral solid phase into solution, there are currently few studies on the chalcopyrite leaching with glycine solutions. Additionally, there are no data on the chalcopyrite leaching using alkaline solutions of lysine, and betaine in the presence of hydrogen peroxide. For this reason, the investigation of chalcopyrite leaching using these reagents is of great interest. The aim of the present work is a comparative study of chalcopyrite leaching in alkaline solutions of glycine, betaine, and lysine in the presence of hydrogen peroxide and the determination of the most effective leaching agent.

## 2. Materials and methods

### 2.1. Research materials

Natural mineral chalcopyrite (90÷95 %  $\text{CuFeS}_2$ ) from the Dzhezkazgan deposit (Kazakhstan) was used as a starting reagent. The mineral was a powdery sample with an average particle size of -250 mesh. The amino acids used as leaching reagents were glycine (Gly, Extra pure grade) and lysine (Lys, 99.00 % pure) from Titan Biotech Ltd (India); betaine (Bet, 99.20 % pure, Zhejiang Medicines & Health Products Imp. & Exp. Co., Ltd, China). All the amino acids have good water solubility and complexing ability and are available, non-toxic and non-volatile reagents. To keep an alkaline medium, sodium hydroxide (Technical grade, OJSC «Reaktiv», Russia) was added to the leaching system. Hydrogen peroxide (Medical grade, LLP «Firma Skat», Kazakhstan) acted as an oxidizing agent in the leaching process. Aqueous solutions of 0.2M Amino acid-0.2M NaOH and 0.2M  $\text{H}_2\text{O}_2$  were used to prepare the leaching mixtures. A solution of 0.2M Amino acid-0.2M NaOH was prepared by co-dissolving the required amount of amino acid and alkali in distilled water.

### 2.2. Leaching procedure

The chalcopyrite leaching in the presence of amino acids and hydrogen peroxide was carried out in an alkaline medium at atmospheric pressure and temperature range of 25÷65 °C in a setup with two intensively shaking glass thermostated «catalytic duck» reactors (Fig. 1). In each reaction vessel (1-2) of 150 cm<sup>3</sup> volume through tubes (5-8) 100 mg of the powdered mineral was introduced, and the reactors were heated to the temperature of the experiment. Then 50 cm<sup>3</sup> of a leaching mixture with a known concentration of each component was added. Solid to liquid (S/L) ratio of 1:500 (0.2 %). 50 cm<sup>3</sup> of 0.1M Amino acid-0.1M NaOH-0.1M  $\text{H}_2\text{O}_2$  leaching solution was prepared by mixing 25 cm<sup>3</sup> of amino acid alkaline solution (0.2M Amino acid-0.2M NaOH) and 25 cm<sup>3</sup> of hydrogen peroxide solution (0.2M

H<sub>2</sub>O<sub>2</sub>). After the addition of the leaching solution, the reactors were closed with rubber stoppers (9-12) and a laboratory autotransformer (15) was switched on to shake the reaction vessels and control the stirring speed of the reaction mixture at 150÷160 rpm. Each temperature of 25 °C, 35 °C, 45 °C, 55 °C or 65 °C was controlled with an accuracy of ±0.10 °C using a LOIP LT-100 immersion thermostat-circulator (16). The duration of the leaching experiment was 5, 10, 20 and 30 min. After the experiment, the solutions from the reactors were filtered to remove the solid phase. Subsequently, the filtrates were analyzed by atomic absorption spectroscopy (AAS, Shimadzu AA-6200, Japan) for the presence of copper and iron ions extracted from the solid phase to the solution. It is worth noting that a new mineral weight was used before each experiment, i.e., liquid samples for AAS analysis were taken at the end of the experiment for 5, 10, 20 and 30 min, respectively.

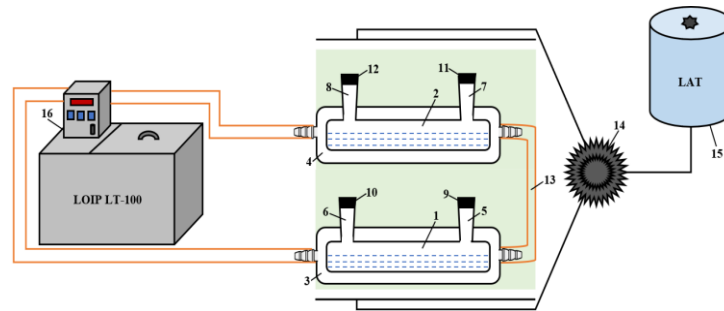

Fig. 1. Scheme of the experimental setup for leaching: 1-2 – reaction vessel, 3-4 – thermostatic jacket, 5-8 – tubes for inputting and outputting of mineral with leaching agent, 9-12 – rubber stoppers, 13 – hose, 14 – motor-wheel, 15 – laboratory autotransformer, 16 – immersion thermostat-circulator

The degree of extraction ( $E$ , %) of metal ions from chalcopyrite into solution was calculated using the following equation:

$$E = \frac{c}{c_{\max}} \cdot 100\% \quad (1)$$

where  $C$  is the concentration of metal ions in solution after leaching, mg/l;  $C_{\max}$  is the maximum concentration of metal ions at full mineral leaching, mg/l.

The maximum concentration of copper and iron ions in solution upon complete leaching of 100 mg of chalcopyrite sample in 50 cm<sup>3</sup> of leaching reagent was calculated to be 692.51 mg/l and 608.60 mg/l, respectively.

### 2.3. Characterization of solid samples

Chalcopyrite samples before and after leaching were analyzed by various Physico-chemical methods. The elemental composition of the initial mineral was analyzed by energy dispersive spectroscopy (EDS) on a scanning electron microscope (Quanta 3D 200i Dual system, FEI Company, USA) equipped with an EDAX microprobe attachment. The specific surface area value of chalcopyrite was determined by BET using a ThermoSorb TPD 1200 (Catakron, Russia) specific surface area analyzer. In order to ensure that the powdered chalcopyrite contains only the mineral phase of interest, the mineral sample was examined by XRD (D8 Advance, Bruker, Germany) using  $K\alpha$ -Cu radiation with a step of 0.02° between 20° and 80° scanning range. Phase identification was carried out in automatic search mode with the Crystallographica Search-Match software using the PDF-2 X-ray powder database. The mineral was also studied by Raman spectroscopy in the 100÷1000 cm<sup>-1</sup> range (Solver Spectrum, NT-MDT, Russia) and by <sup>57</sup>Fe Mössbauer spectroscopy on a spectrometer (NZ-640, Hungary) supplied with <sup>57</sup>Co(Rh) source and operating in constant acceleration mode.

## 3. Results and discussion

### 3.1. Results

#### 3.1.1. EDS study of the initial sulfide mineral

The chalcopyrite sample was analyzed for its elemental composition. Fig. 2 shows the EDS spectrum where strong peaks of copper, iron, and sulfur can be seen. The result of the EDS analysis indicates that

the chemical composition of the initial mineral complies with the theoretical data on the mass fractions of copper, sulfur, and iron (Wt: 35.57 % Cu, 31.68 % Fe, 24.34 % S).

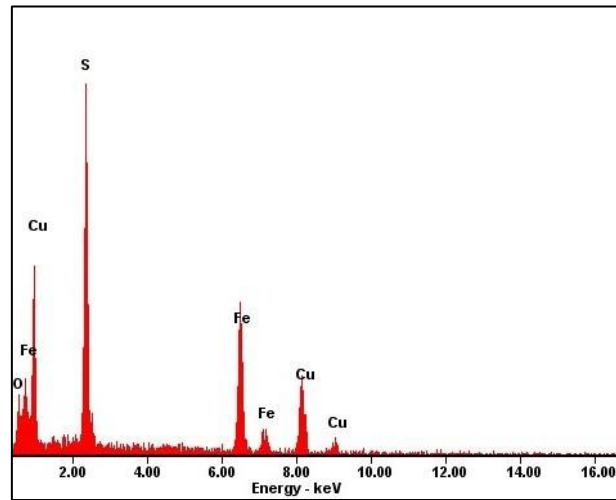

Fig. 2. EDS spectrum of  $\text{CuFeS}_2$

### 3.1.2. Amino acid leaching of chalcopyrite in the presence of hydrogen peroxide in an alkaline medium

The kinetic curves of chalcopyrite leaching in alkaline solutions of glycine, betaine, and lysine with the oxidant hydrogen peroxide at 25 °C are shown in Fig. 3. These curves show that the concentration of extracted copper ions from the solid phase into solution rises in all three systems as the leaching time increases. According to the data on chalcopyrite leaching for 30 min, the values of copper concentration in solutions of 0.1M Gly-0.1M NaOH-0.1M  $\text{H}_2\text{O}_2$ , 0.1M Bet-0.1M NaOH-0.1M  $\text{H}_2\text{O}_2$ , 0.1M Lys-0.1M NaOH-0.1M  $\text{H}_2\text{O}_2$  were  $25.07 \pm 0.27$  mg/l,  $15.53 \pm 0.91$  mg/l,  $10.54 \pm 0.06$  mg/l, while the copper extraction degrees were 3.62 %, 2.24 %, 1.52 %, respectively. Notably, over the same time period, the degree of iron extraction from chalcopyrite in solution compared to copper extraction was significantly lower and was equal to 0.02 mg/l (0.00 %), 1.71 mg/l (0.28 %), 0.43 mg/l (0.07 %) in systems with Gly, Bet, Lys, respectively.

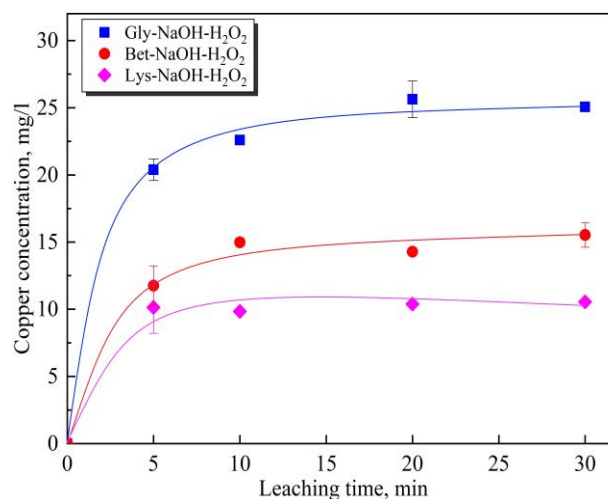

Fig. 3. Dependence of extracted copper ions concentration in the system 0.1M Amino acid-0.1M NaOH-0.1M  $\text{H}_2\text{O}_2$  on leaching time

Furthermore, the effect of temperature on chalcopyrite leaching in all three systems was studied. Increasing the temperature of the process from 25 °C to 65 °C has a positive effect on the copper leaching from the mineral into the solution (Fig. 4). The concentrations of extracted copper for 10 min at 65 °C reached  $53.74 \pm 0.02$  mg/l,  $43.33 \pm 0.91$  mg/l,  $16.60 \pm 0.39$  mg/l in systems 0.1M Gly-0.1M NaOH-0.1M

H<sub>2</sub>O<sub>2</sub>, 0.1M Bet-0.1M NaOH-0.1M H<sub>2</sub>O<sub>2</sub>, 0.1M Lys-0.1M NaOH-0.1M H<sub>2</sub>O<sub>2</sub>, respectively. Also, the extraction degrees in these systems were 7.76 %, 6.26 %, and 2.40 %. Increasing the temperature to 65 °C did not affect the concentration of extracted iron ions in the solution. In systems with Gly, Bet, Lys the amount of leached iron was equal to 0.17 mg/l (0.03 %), 0.05 mg/l (0.01 %), 0.36 mg/l (0.06 %), respectively.

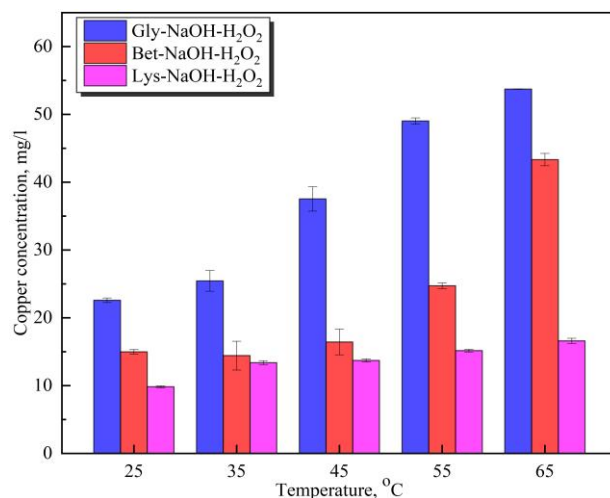

Fig. 4. Dependence of extracted copper ions concentration in the system 0.1M Amino acid-0.1M NaOH-0.1M H<sub>2</sub>O<sub>2</sub> on temperature

### 3.1.3. Specific leaching rate

The study of the kinetics of chalcopyrite leaching in complexing reagents was carried out, taking into account the similarity of chemical reactions. This condition allows the kinetic laws to be described by a single Dolivo-Dobrovolskii equation, characteristic of heterogeneous process on the solid-liquid interface (Dolivo-Dobrovolskii, 1963), which was used to determine the specific leaching rate of chalcopyrite:

$$W = \frac{\Delta C \cdot V}{S_0 \cdot m \cdot \eta^{2/3} \cdot \Delta t} \quad (2)$$

where  $\Delta C$  is the concentration of metal transferred from the solid into the solution during the time  $\Delta t$ , mol/l;  $V$  is the volume of leaching reagent, l;  $S_0$  is the specific surface area of the mineral, m<sup>2</sup>/g;  $m$  is the mass of the mineral sample, g;  $\eta$  is the fraction of unreacted mineral;  $\Delta t$  is the leaching time, s.

The value of the specific surface area determined by the BET method for chalcopyrite was 1.8 m<sup>2</sup>/g. The calculated values of the specific leaching rate of chalcopyrite at atmospheric pressure and temperature are presented in Table 1. As the duration of the experiment increases, the specific leaching rates of chalcopyrite decrease. Based on the comparison of the specific leaching rates ( $W$ , mol/(m<sup>2</sup>·s)) of chalcopyrite, the leaching ability of the amino acids declines in a series of amino acids glycine > betaine > lysine.

Table 1. Specific leaching rates of CuFeS<sub>2</sub> in alkaline solutions of glycine, betaine, lysine, and hydrogen peroxide

System	W, mol/(m <sup>2</sup> ·s)			
	300 s	600 s	1200 s	1800 s
0.1M Gly-0.1M NaOH-0.1M H <sub>2</sub> O <sub>2</sub>	3.03 · 10 <sup>-7</sup>	1.68 · 10 <sup>-7</sup>	0.96 · 10 <sup>-7</sup>	0.62 · 10 <sup>-7</sup>
0.1M Bet-0.1M NaOH-0.1M H <sub>2</sub> O <sub>2</sub>	1.73 · 10 <sup>-7</sup>	1.11 · 10 <sup>-7</sup>	0.53 · 10 <sup>-7</sup>	0.38 · 10 <sup>-7</sup>
0.1M Lys-0.1M NaOH-0.1M H <sub>2</sub> O <sub>2</sub>	1.49 · 10 <sup>-7</sup>	0.72 · 10 <sup>-7</sup>	0.38 · 10 <sup>-7</sup>	0.26 · 10 <sup>-7</sup>

Thus, according to this kinetic series and experimental results, the alkaline glycine solution proved to be the most effective. Detailed Physico-chemical investigations of leached chalcopyrite residues in glycine solutions are given below.

### 3.1.4. Mineral investigation before and after glycine leaching by Physico-chemical methods

#### 3.1.4.1. XRD analysis

The analysis of the obtained X-ray diffraction patterns (Fig. 5a) shows that only strong peaks of the chalcopyrite phase with tetragonal structure and the lattice parameters  $a=5.29 \text{ \AA}$  and  $c=10.42 \text{ \AA}$  (PDF #71-507) were present in the sample. This confirms the high purity and the monomineral nature of the sample. Fig. 5b and 5c indicate that the chalcopyrite structure retained a dominant position during the leaching of the samples in alkaline solutions of glycine and hydrogen peroxide at  $25 \text{ }^\circ\text{C}$  and  $65 \text{ }^\circ\text{C}$ , respectively. The presence of peaks characteristic of chalcopyrite in the leached residues can be explained by the fact that the mineral sample has not been fully oxidized.

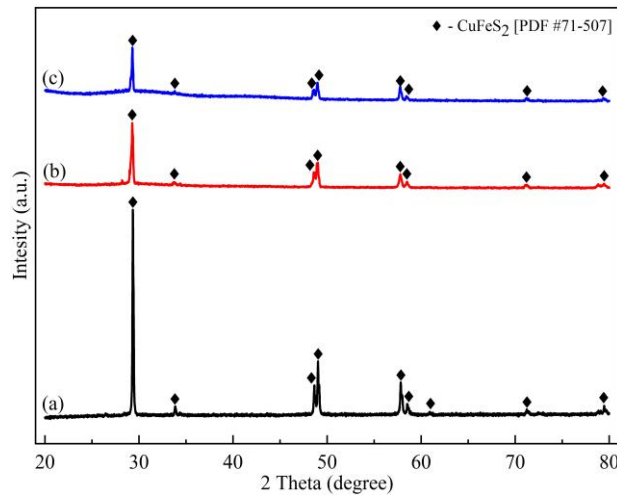

Fig. 5. XRD patterns of  $\text{CuFeS}_2$ : initial (a), after leaching in alkaline glycine solution and hydrogen peroxide at  $25 \text{ }^\circ\text{C}$  (b) and  $65 \text{ }^\circ\text{C}$  (c)

#### 3.1.4.2. Raman spectroscopy

The Raman spectrum of the initial sample (Fig. 6a) contains peaks of both elemental sulfur and chalcopyrite. A relatively broad peak typical for highly crystalline chalcopyrite was detected at  $290 \text{ cm}^{-1}$ . Also, the shoulder at  $318 \text{ cm}^{-1}$  and another shoulder at  $351 \text{ cm}^{-1}$  indicate chalcopyrite. Elemental sulfur was detected with distinct peaks due to S-S-S bending at  $221 \text{ cm}^{-1}$ , and S-S stretching at  $469 \text{ cm}^{-1}$  (O'Connor et al., 2018a). Changes in the Raman spectra of the samples can be seen after glycine leaching at  $25 \text{ }^\circ\text{C}$  (Fig. 6b) and  $65 \text{ }^\circ\text{C}$  (Fig. 6c). The Raman spectrum revealed a noticeable disappearance of the elemental sulfur peaks compared to the initial sample. This fact allows to consider glycine as an effective copper leaching agent, which does not slow down the process kinetics by passivation of the chalcopyrite surface. Remarkably, in earlier works (O'Connor et al., 2018a; O'Connor et al., 2018b) electrochemical studies of the anodic dissolution of chalcopyrite in alkaline glycine solutions have been carried out. It was proved that in contrast to acidic solutions, in alkaline solutions with the above-mentioned complexing agent, no visible passivation effects were observed.

#### 3.1.4.3. Mössbauer spectroscopy

Fig. 7 shows the  $^{57}\text{Fe}$  Mössbauer spectra of chalcopyrite. For the initial sample (Fig. 7a), the sextet ( $\text{Fe}^{3+}$ ) with hyperfine splitting  $H=35.30 \text{ T}$ , isomeric shift  $IS=0.25 \text{ mm/s}$ , quadrupole splitting  $QS=-0.01 \text{ mm/s}$  and line width  $G=0.25 \text{ mm/s}$ , typical for  $\text{CuFeS}_2$ , give the dominant contribution. The second contribution as a doublet ( $\text{Fe}^{2+}$ ) in the spectrum was represented by the szomolnokite phase ( $\text{FeSO}_4 \cdot \text{H}_2\text{O}$ ) with  $IS=1.26 \text{ mm/s}$ ,  $QS=2.79 \text{ mm/s}$  and  $G=0.35 \text{ mm/s}$ . The relative contents of  $\text{CuFeS}_2$  and  $\text{FeSO}_4 \cdot \text{H}_2\text{O}$ , based on the ratio of the spectral areas, were about 96 % and 4 %, respectively. On the spectra of the sample after leaching (Fig. 7b), only the sextet with  $H=35.00 \text{ T}$ ,  $IS=0.25 \text{ mm/s}$ ,  $QS=0.00 \text{ mm/s}$ ,  $G=0.26 \text{ mm/s}$  dominated, and its area fraction increased to 100 %. The disappearance of the doublet on the spectrum proposes that the  $\text{Fe}^{2+}$  cations of the szomolnokite were oxidized to  $\text{Fe}^{3+}$  during the leaching process. It should be noted that in the main chalcopyrite phase the  $\text{Fe}^{3+}$  cations are in a

tetrahedral surrounding of sulfur anions, while in the szomolnokite the  $\text{Fe}^{2+}$  cations are located in an oxygen octahedron (Alboom et al., 2009; Senkale et al., 2021).

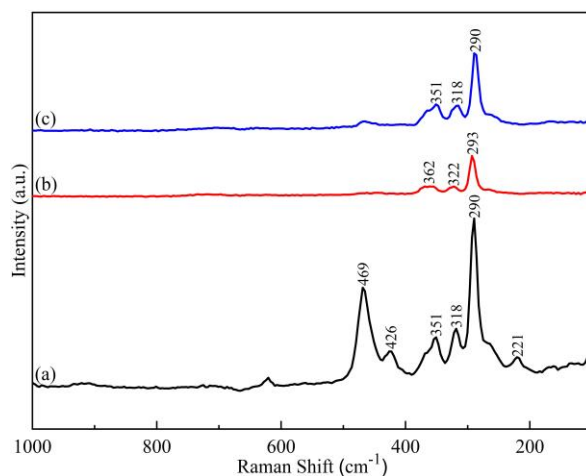

Fig. 6. Raman spectra of  $\text{CuFeS}_2$ : initial (a), after leaching in alkaline glycine solution and hydrogen peroxide at 25 °C (b) and 65 °C (c)

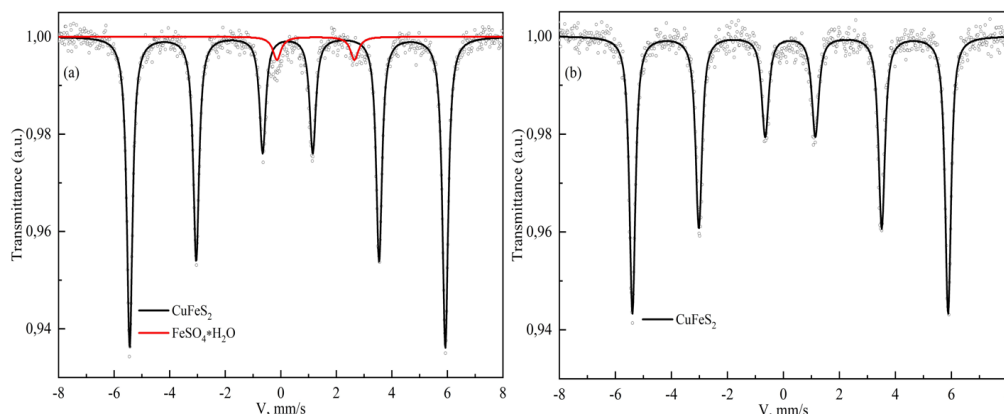

Fig. 7.  $^{57}\text{Fe}$  Mössbauer spectra of  $\text{CuFeS}_2$ : initial (a), after leaching in alkaline glycine solution and hydrogen peroxide (b)

### 3.2. Discussion

All amino acids are known to be amphoteric compounds; they can exhibit acid-base properties. The acidic and basic properties are due to the presence of a carboxylic group ( $-\text{COOH}$ ) and an amino group ( $-\text{NH}_2$ ), respectively. Each amino acid has its isoelectric point  $pI$ , i.e., the  $pH$  value of the medium in which the amino acid exists as a zwitter ion, having a positive charge on the amino group and a negative charge on the carboxy group (Kitadai et al., 2009; Perelygin et al., 2018). The zwitter ion can gain a proton by forming a cation or lose a proton by reacting with a hydroxyl to form an anion. Each amino acid is characterized by values of dissociation constants ( $pK$ ) of acid-base transformations between zwitter-ion and ionic forms. Fig. 8 shows the acid-base transformations of glycine, betaine, and lysine depending on  $pH$ . Glycine and lysine are characterized by two and three acid-base transformations with dissociation constants  $pK_1=2.34$ ,  $pK_2=9.60$  and  $pK_1=2.20$ ,  $pK_2=9.00$ ,  $pK_3=10.50$ , respectively. When  $pH < pK_1$ , only glycine cations and lysine dications are in solution and do not interact with copper ions. Consequently, amino acid leaching of copper in an acidic medium will be worse than in a neutral and alkaline medium. If  $pK_1 < pH < pI$  for glycine and  $pK_2 < pH < pI$  for lysine, the amino acids are in solution as cation and zwitter ion. When  $pI < pH < pK_2$  for glycine and  $pI < pH < pK_3$  for lysine, the amino acids are in the form of a zwitter ion and an anion. Glycinate and lysinate anions are dominant in the solution when  $pH > pK_2$  and  $pH > pK_3$ , respectively. It should be noted that betaine is a permanent zwitter ion in solution with  $pI=3.00-3.30$  (Zheng et al., 2005; Kim et al., 2009).

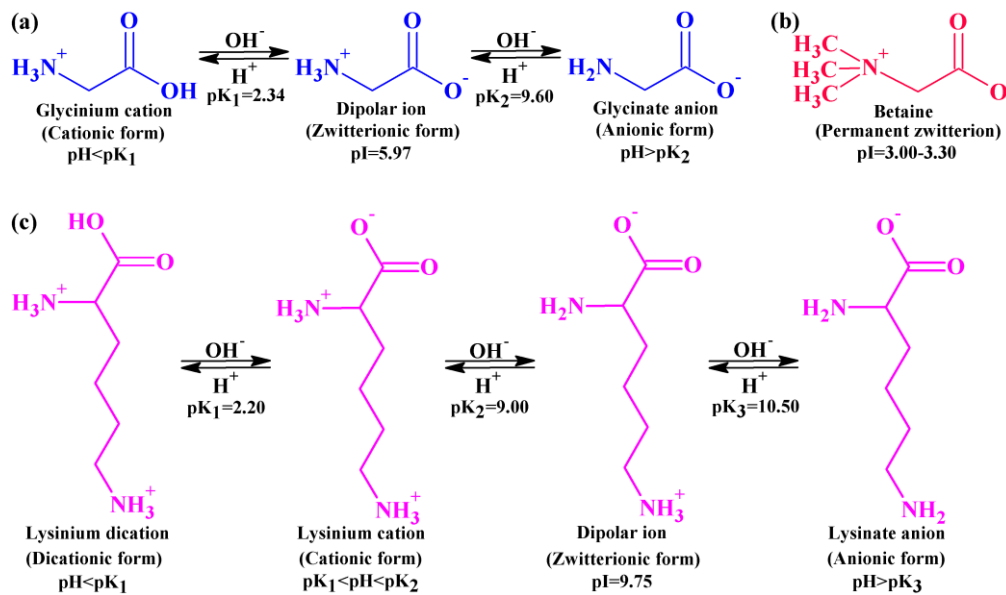

Fig. 8. Acid-base transformations of glycine (a), betaine (b) and lysine (c)

According to the aforementioned information, amino acid deprotonation takes place at high pH values. In this regard, it is advisable to carry out the chalcopyrite leaching process in an alkaline medium where positive copper ions interact with negative amino acid ions that are dominant in the solution. Thus, carboxylic groups and amino groups of anionic forms of amino acids are involved in the formation of strong copper (II) chelate complexes.

The leaching results (from 3.1.2.) indicate that copper was extracted from the chalcopyrite into the solution more than iron. In addition, it can be argued that in the solution there was hardly any leached iron. In this regard, amino acid leaching of chalcopyrite is a selective method of extracting copper ions.

A comparison of the leaching ability of the three amino acids showed that glycine was the most effective reagent. The next most effective is betaine. Among the examined amino acids, betaine extracted the most iron at room temperature, so its application as a selective leaching agent is questionable. When using the system with lysine, the values of copper ion concentrations in the solution were lower than in the system with glycine and betaine. This is probably due to a deficiency of lysinate anions formed predominantly at  $\text{pH} > 10.50$ . In the system 0.1M Lys-0.1M NaOH-0.1M  $\text{H}_2\text{O}_2$ , the experimental pH value of the medium was  $9.60 \div 9.80$ . Similarly, in experiments regarding the effect of temperature on the leaching process of chalcopyrite, the effectiveness of glycine over lysine and betaine was confirmed. The higher leaching ability of glycine among the considered amino acids is explained by the greater strength of the formed complex with copper in the series copper glycinate > copper lysinate > copper betainate, as an increasing chain length in amino acids leads to lower stability constant of copper complexes with amino acids (Doğan et al., 2001).

It should be noted that the hydrogen peroxide used as an oxidant in this study can decompose at high temperatures. Since the decomposition products of hydrogen peroxide are oxygen and water, this oxidizer is a non-toxic, environmentally friendly reagent. It was mentioned by the authors (Pędziwiatr et al., 2018) that the hydrogen peroxide decomposition reaction is very slow at moderate temperatures. This reaction can be accelerated by raising the temperature, i.e., a higher temperature increases the degree of hydrogen peroxide decomposition. Also, hydrogen peroxide in low concentrations is chemically unstable.

In (Yazici and Deveci, 2010) the authors considered the effect of temperature on the decomposition of hydrogen peroxide with a concentration of 800 mg/l in an alkaline medium ( $\text{pH} = 10.5 \div 11$ ). At 20 °C and 30 °C, there was almost no decomposition of  $\text{H}_2\text{O}_2$  for 30 min, but at 50 °C during the same time, 25 % of the oxidant had decomposed. In a paper (Morozow et al., 2014), the kinetics of the decomposition of aqueous hydrogen peroxide solutions were studied. When the initial concentration of hydrogen peroxide was 150 mg/l, the degree of hydrogen peroxide decomposition in an alkaline medium ( $\text{pH} = 10$ ) within 30 min was about 14 % and 15 % at 50 °C and 70 °C, respectively. At 50 °C and 70 °C, the



decomposition rate of hydrogen peroxide increases during the first 20 minutes of the experiment, and then the decomposition process stops almost completely. The authors also studied the effect of the initial concentration of hydrogen peroxide (50÷250 mg/l) on its decomposition kinetics in an alkaline medium (pH=10) at 70 °C for 60 min. It was found that with an increasing initial concentration of hydrogen peroxide its decomposition degree monotonically decreases from 14.5 % at 50 mg/l to 9.2 % at 250 mg/l.

Given the fact that the present work uses 0.1 M H<sub>2</sub>O<sub>2</sub> (3401 mg/l), the degree of hydrogen peroxide decomposition in the temperature range of 25÷65 °C will be much lower than in the aforementioned works (Morozow et al., 2014; Yazici and Devenci, 2010). Accordingly, during 5, 10, 20 and 30 min of chalcopyrite leaching the decomposition of hydrogen peroxide and thus the reduction of its concentration in the leached solution should be negligible.

Previously, researchers (O'Connor et al., 2018a) presented chalcopyrite leaching in glycine solutions in an alkaline medium as a half-reaction:

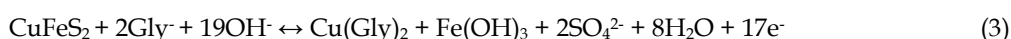

Similar to this mechanism, the amino acid leaching of chalcopyrite by glycine, betaine, lysine in an alkaline medium in the presence of hydrogen peroxide that proceeds with the formation of glycinate, betainates and lysinate of copper (II) can be represented by the following reaction equations:

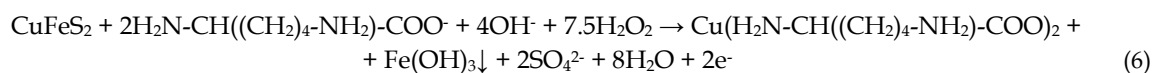
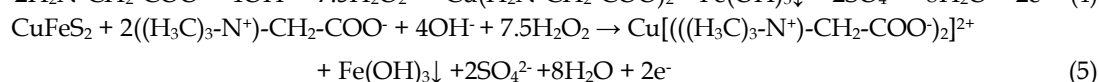
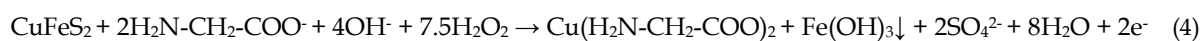

However, according to XRD, Raman spectroscopy and Mössbauer spectroscopy there was no change in the structure of chalcopyrite after leaching. XRD analysis showed that the phases aside from chalcopyrite were not detected in the initial mineral before and after leaching. This suggests that the chalcopyrite phase remained unchanged after 30 min of leaching. It is necessary to note that chalcopyrite was leached the most in alkaline solutions of glycine and hydrogen peroxide (by 3.62 % at 25 °C and by 7.76 % at 65 °C). Consequently, more than 90 % of the copper remained in the mineral phase. The iron concentrations detected by AAS in the filtrate are presumably due to the leaching of szomolnokite from the chalcopyrite surface.

Based on the results of physico-chemical analyses in this article and research in (Warren and Wadsworth, 1984), the following schemes for amino acid leaching of chalcopyrite with glycine, betaine, and lysine in an alkaline medium were proposed:

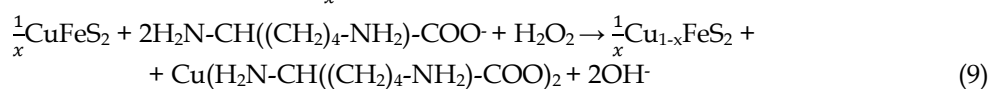
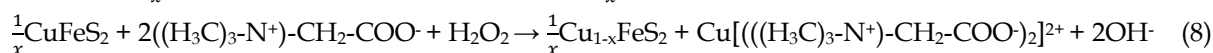
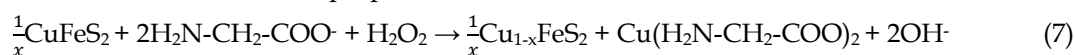

These reactions correspond better to our experimental results compared to reactions (4)-(6).

#### 4. Conclusions

The paper demonstrated that the nature of the amino acid, the presence of the oxidant H<sub>2</sub>O<sub>2</sub> and the temperature have an influence on the kinetics, yield, and selectivity of copper leaching from natural chalcopyrite. The specific leaching rate of chalcopyrite and the reaction yield were the highest in the system based on alkaline glycine solution and hydrogen peroxide. This indicates a good leaching ability of glycine among the considered amino acids, which is due to the higher strength of the formed complex with copper in the series of copper glycinate > copper lysinate > copper betainate, as increasing the chain length in the amino acids leads to lower stability constant of the complex. Raising the temperature from 25 °C to 65 °C during the amino acid leaching of chalcopyrite causes a notable improvement in copper ion extraction from the mineral into the solution compared to the results at room temperature. The concentration of extracted copper ions for 10 min was increased by a factor of 2.38, 2.89, 1.69 at 65 °C for systems with glycine, betaine and lysine, respectively. The improved extraction efficiency

indicates the important role of temperature in enhancing leaching kinetics. It is important to emphasize that glycine, betaine and lysine selectively leached copper from chalcopyrite. The iron present in  $\text{CuFeS}_2$  was not practically leached by amino acids. The degree of iron extraction from chalcopyrite into solution was close to zero, while the degree of copper extraction ranged from 1.52 % to 7.76 %. It is necessary to note that XRD, Raman and Mössbauer spectroscopy methods have not revealed any compounds except initial chalcopyrite in mineral samples after leaching. This indicates the mechanism of selective copper leaching (equations (7)-(9)) due to the formation of chalcopyrite-based solid solution  $\text{Cu}_{1-x}\text{FeS}_2$ .

Based on the results of the research, amino acids, in particular, glycine, betaine and lysine can be used as promising, environmentally friendly reagents for chalcopyrite leaching. The obtained results open a new industrially important alternative direction for future hydrometallurgical research, focused on the development of a low-temperature method of copper ions leaching from the solid phase of sulfide minerals into solution.

### Acknowledgements

The authors of this paper gratefully acknowledge Askar Orazalin from the Metal Analysis Laboratory of the Center of Physico-Chemical Methods of Research and Analysis at Al-Farabi KazNU for his assistance in the atomic absorption study; Gulzhan Baigarinova and Renata Nemkayeva from National Nanotechnology Laboratory of Open Type at Al-Farabi KazNU for their assistance in the mineral analysis by EDS and Raman spectroscopy, respectively; Vyacheslav Khusnutdinov and Arina Ukhina from Institute of Solid State Chemistry and Mechanochemistry of SB RAS for their assistance in the mineral investigation by BET and XRD, respectively.

### References

- ALBOOM, A.V., DE RESENDE, V.G., DE GRAVE, E., GÓMEZ, J.A.M., 2009. *Hyperfine interactions in szomolnokite ( $\text{FeSO}_4 \cdot \text{H}_2\text{O}$ )*. Journal of Molecular Structure. 924-926, 448-456.
- AZADI, M.R., KARRECH, A., ELCHALAKANI, M., ATTAR, M., 2019. *Microfluidic study of sustainable gold leaching using glycine solution*. Hydrometallurgy. 185, 186-193.
- BEIZA, L., QUEZADA, V., MELO, E., VALENZUELA, G., 2019. *Electrochemical behaviour of chalcopyrite in chloride solutions*. Metals. 9(1), 1-12.
- BHARGAVA, S.K., POWNCEBY, M.I., RAM, R., 2016. *Hydrometallurgy*. Metals. 6(5), 17-19.
- CARLESÌ, C., HARRIS, R.C., ABBOTT, A.P., JENKIN, G.R.T., 2022. *Chemical Dissolution of Chalcopyrite Concentrate in Choline Chloride Ethylene Glycol Deep Eutectic Solvent*. Minerals. 12(1), 65.
- CHOUBEY, P.K., LEE, J., KIM, M., KIM, H-S., 2018. *Conversion of chalcopyrite to copper oxide in hypochlorite solution for selective leaching of copper in dilute sulfuric acid solution*. Hydrometallurgy. 178, 224-230.
- DOĞAN, A., KÖSEOĞLU, F., KILIÇ, E., 2001. *The Stability Constants of Copper(II) Complexes with Some  $\alpha$ -Amino Acids in Dioxan-Water Mixtures*. Analytical Biochemistry. 295, 237-239.
- DOLIVO-DOBROVOL'SKII, V.V., 1963. *Some laws of the dissolution process of a dispersed solid*. Journal of Mining Institute. 42(3), 3-24.
- EKSTEEN, J.J., ORABY, E.A., TANDA, B.C., 2017. *A conceptual process for copper extraction from chalcopyrite in alkaline glycinate solutions*. Minerals Engineering. 108, 53-66.
- GHOMI, M.A., MOZAMMEL, M., MOGHANNI, H., SHAHKAR, L., 2019. *Atmospheric leaching of chalcopyrite in the presence of some polar organic reagents: A comparative study and optimization*. Hydrometallurgy. 189, 105120.
- KARTAL, M., XIA, F., RALPH, D., RICKARD, W.D.A., RENARD, F., LI, W., 2020. *Enhancing chalcopyrite leaching by tetrachloroethylene-assisted removal of sulphur passivation and the mechanism of jarosite formation*. Hydrometallurgy. 191, 105192.
- KIM, J.S., PARK, J.S., LIM, J.C., 2009. *Measurement of Isoelectric Point of Betaine Zwitterionic Surfactant by QCM (Quartz Crystal Microbalance)*. Korean Chemical Engineering Research. 47(1), 31-37.
- KITADAI, N., YOKOYAMA, T., NAKASHIMA, S., 2009. *ATR-IR spectroscopic study of L-lysine adsorption on amorphous silica*. Journal of Colloid and Interface Science. 329(1), 31-37.
- LIANG, C., XIA, J., NIE, Z., LUO, X., 2013. *Comparison of electrochemical behaviors of chalcopyrite, bornite, chalcocite and covellite in 9K medium*. Advanced Materials Research. 634-638(1), 68-71.

- MARTÍNEZ-GÓMEZ, V.J., FUENTES-ACEITUNO, J.C., PÉREZ-GARIBAY, R., LEE, JAE-CHUN., 2018. *A study of the electro-assisted reductive leaching of a chalcopyrite concentrate in HCl solutions. Part I: Kinetic behavior and nature of the chalcopyrite reduction.* Hydrometallurgy. 181, 195–205.
- MOROZOW, A.R., RODIONOW, A.I., KAMENCHUK, I.N., 2014. *Kinetics of decomposition of hydrogen peroxide in water.* Advances in chemistry and chemical technology. 28(5), 46–49.
- MOYO, T., PETERSEN, J., NICOL, M.J., 2018. *The electrochemistry and kinetics of the oxidative dissolution of chalcopyrite in ammoniacal solutions: Part I – Anodic Reactions.* Hydrometallurgy. 182, 97–103.
- MOYO, T., PETERSEN, J., NICOL, M.J., 2019. *The electrochemistry and kinetics of the oxidative dissolution of chalcopyrite in ammoniacal solutions. Part II – Cathodic reactions.* Hydrometallurgy. 184, 67–74.
- O'CONNOR, G.M., LEPKOVA, K., EKSTEEN, J.J., ORABY, E.A., 2018a. *Electrochemical behaviour and surface analysis of chalcopyrite in alkaline glycine solutions.* Hydrometallurgy. 182, 32–43.
- O'CONNOR, G.M., LEPKOVA, K., EKSTEEN, J.J., ORABY, E.A., 2018b. *Electrochemical behaviour of copper in alkaline glycine solutions.* Hydrometallurgy. 181, 221–229.
- OLVERA, O.G., REBOLLEDO, M., MORA, N., DIXON, D.G., ASSELIN, E., 2018. *Electrochemical dissolution of chalcopyrite in the presence of thiourea and formamidine disulfide.* Hydrometallurgy. 179, 110–117.
- OLVERA, O.G., VALENZUELA, P., DIXON, D.G., ASSELIN, E., 2017. *Effect of cysteine on the electrochemical dissolution of chalcopyrite.* Hydrometallurgy. 169, 552–563.
- ORABY, E.A., EKSTEEN, J.J., TANDA, B.C., 2017. *Gold and copper leaching from gold-copper ores and concentrates using a synergistic lixiviant mixture of glycine and cyanide.* Hydrometallurgy. 169, 339–345.
- PANDA, S., SANJAY, K., SUKLA, L.B., PRADHAN, N., SUBBAIAH, T., MISHRA, B.K., PRASAD, M.S.R., RAY, S.K., 2012. *Insights into heap bioleaching of low grade chalcopyrite ores – A pilot scale study.* Hydrometallurgy. 125–126, 157–165.
- PEŃZIWIATR, P., MIKOŁAJCZYK, F., ZAWADZKI, D., MIKOŁAJCZYK, K., BEDKA, A., 2018. *Decomposition of hydrogen peroxide-kinetics and review of chosen catalysts.* Acta Innovations. 26, 45–52.
- PERELYGIN, YU.P., JASKULA, M., KOLTSHUGINA, I.G., 2018. *Some Remarks on the Meaning of Isoelectric Point of Glycine.* Jordan Journal of Physics. 11(1), 1–3.
- RUIZ-SÁNCHEZ, Á., LAPIDUS, G.T., 2017. *Study of chalcopyrite leaching from a copper concentrate with hydrogen peroxide in aqueous ethylene glycol media.* Hydrometallurgy. 169, 192–200.
- SAFARZADEH, M.S., LI, J., MOATS, M.S., MILLER, J.D., 2012. *The stability of selected sulfide minerals in sulfuric acid and acidic thiocyanate solutions.* Electrochimica Acta. 78, 133–138.
- SENKALE, S., INDRIS, S., ETTER, M., BENSCH, W., 2021. *CuFeS<sub>2</sub> as a Very Stable High-Capacity Anode Material for Sodium-Ion Batteries: A Multimethod Approach for Elucidation of the Complex Reaction Mechanisms during Discharge and Charge Processes.* ACS Applied Materials and Interfaces. 13(22), 26034–26045.
- SHEIKHIAN, L., AKHOND, M., ABSALAN, G., 2020. *Specification of Zwitterionic or Non-Zwitterionic Structures of Amphoteric Compounds by Using Ionic Liquids.* Acta Chimica Slovenica. 67(2), 415–420.
- SHIN, D., AHN, J., LEE, J., 2019. *Kinetic study of copper leaching from chalcopyrite concentrate in alkaline glycine solution.* Hydrometallurgy. 183, 71–78.
- SOLÍS MARCIAL, O.J., NÁJERA BASTIDA, A., BAÑUELOS, J.E., VALDÉS MARTÍNEZ, O.U., LUEVANO, L.A., SERRANO ROSALES, B., 2019. *Chalcopyrite Leaching Kinetics in the Presence of Methanol.* International Journal of Chemical Reactor Engineering. 17(12), 1–10.
- SOLIS-MARCÍAL, O.J., LAPIDUS, G.T., 2013. *Improvement of chalcopyrite dissolution in acid media using polar organic solvents.* Hydrometallurgy. 131–132, 120–126.
- TIBURCIO-MUNIVE, G., SALAZAR-CAMPOY, M.M., VALENZUELA-GARCÍA, J.L., HERNÁNDEZ-NEGRETE, O., VÁZQUEZ-VÁZQUEZ, V., 2020. *Dissolution of Silver and Gold with Sodium Hypochlorite and Hydrochloric Acid in Refractory Minerals (Mangano-Argentiferous).* Mining, Metallurgy and Exploration. 37(4), 1213–1220.
- WARREN, G.W., WADSWORTH, M.E., 1984. *The electrochemical oxidation of chalcopyrite in ammoniacal solutions.* Metallurgical Transactions B. 15 (2), 289–297.
- YAZICI, E.Y., DEVECI, H., 2010. *Factors affecting decomposition of hydrogen peroxide.* Proceedings of the XII<sup>th</sup> international mineral processing symposium. 609–616.
- YOO, K., KIM, S., LEE J., ITO, M., TSUNEKAWA, M., HIROYOSHI, N., 2010. *Effect of chloride ions on leaching rate of chalcopyrite.* Minerals Engineering. 23(6), 471–477.

- ZHAO, H., WANG, J., GAN, X., QIN, W., HU, M., QIU, G., 2015. *Bioleaching of chalcopyrite and bornite by moderately thermophilic bacteria: an emphasis on their interactions*. International Journal of Minerals, Metallurgy and Materials. 22(8), 777-787.
- ZHAO, H., ZHANG, Y., ZHANG, X., QIAN, L., SUN, M., YANG, Y., ZHANG, Y., WANG, J., KIM, H., QIU, G., 2019. *The dissolution and passivation mechanism of chalcopyrite in bioleaching: An overview*. Minerals Engineering. 136(932), 140-154.
- ZHENG, W., XU, S., RADISIC, D., STOKES, S., LI, X., BOWEN, K.H., 2005. *On the interaction of electrons with betaine zwitterions*. The Journal of Chemical Physics. 122(10), 1-4.